

CombiMag / Bloc

Magnetic Drive Centrifugal Pumps



Safe and Leak-Proof Design

CombiMag and CombiMagBloc represent a range of leak-proof pumps for applications which convey corrosive, toxic, aggressive or expensive liquids.

Total containment of the liquid inside the pump is achieved using a hermetically sealed can, which isolates the liquid from the surrounding environment. This eliminates the need for mechanical seals and the associated wear and leakage that would normally be experienced with pumps which incorporate mechanical seal design. The Magnetic Drive pumps are therefore not only environmentally friendly – they also contribute to improved safety in chemical and process plant environments.

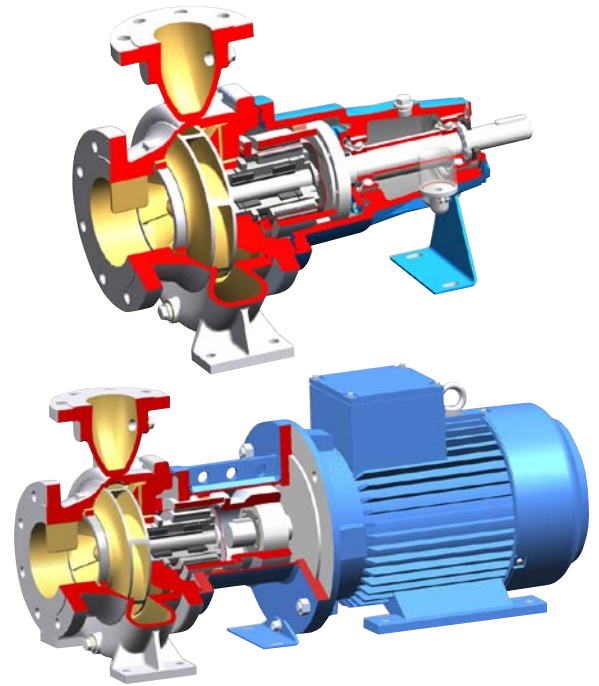

Combi Concept

- Very easy upgrading of mechanically sealed pumps to hermetically sealed magnetic drive pumps
- Interchangeability of Back-Pull-Out units with CombiChem, CombiNorm, CombiPro
-  ATEX certified applications
- Extended MTBF (Mean Time Between Failure)
- Reduced repair costs

Easy Maintenance

- Contained Back-Pull-Out, the pump cover with containment can remain bolted to the pump casing for drive end maintenance
- Pump does not need to be drained
- System remains pressurised
- Simple assembly through optimized design

Advantages

- Leak-proof
- Easy maintenance
- Ensures clean, safe and leak-proof operating environment
- High degree of parts compatibility
- Short delivery times
- Total product containment

	COMBIMAG	COMBIMAGBLOC
STANDARD	ISO 5199, ISO2858 / EN 22858	ISO 5199, ISO2858 / EN 22858
DESIGN	FRAME MOUNTED LONG COUPLED DESIGN	CLOSE COUPLED DESIGN
CAPACITY	UP TO 550 M ³ /H	UP TO 280 M ³ /H
HEAD	UP TO 160 M	UP TO 140 M
MAX. SYSTEM PRESSURE	1600 KPA (16 BAR), 2500 KPA (25 BAR) OPTIONAL	1600 KPA (16 BAR), 2500 KPA (25 BAR) OPTIONAL
TEMPERATURE	-50 °C UP TO 300 °C, 350 °C OPTIONAL	-50 °C UP TO 200 °C
MIN. VISCOSITY	0.3 MPAS	0.3 MPAS
MAX. VISCOSITY	150 MPAS	150 MPAS
SLURRY	MAXIMUM 5% WEIGHT, SIZE MAXIMUM 250 µM	MAXIMUM 5% WEIGHT, SIZE MAXIMUM 250 µM
SOLIDS	MAXIMUM DIAMETER 0.1 MM, HARDNESS 700 HV	MAXIMUM DIAMETER 0.1 MM, HARDNESS 700 HV
MAGNETS	SAMARIUM COBALT (SMCO)	SAMARIUM COBALT (SMCO)
PLAIN BEARINGS	SILICON CARBIDE (SIC)	SILICON CARBIDE (SIC)
CAN	"HASTELLOY C4 [®] "	"HASTELLOY C4 [®] "
INNER ROTOR	DUPLEX / "HASTELLOY C4 [®] "	DUPLEX / "HASTELLOY C4 [®] "
MAX. POWER AT 3000 RPM	75 KW	45 KW
MOTOR FRAME SIZE RANGE	IEC 80 - 280S/M	IEC 80 - 112M IM3001 (B5) IEC 132S/M - 225S/M IM2001 (B3/B5)
AVAILABLE MATERIALS	STAINLESS STEEL, NODULAR CAST IRON, CAST IRON, DUPLEX, ALLOY 20, HASTELLOY C [®]	STAINLESS STEEL, NODULAR CAST IRON, CAST IRON, DUPLEX, ALLOY 20, HASTELLOY C [®]

Performance curves

Versatile Application Range

1500 rpm

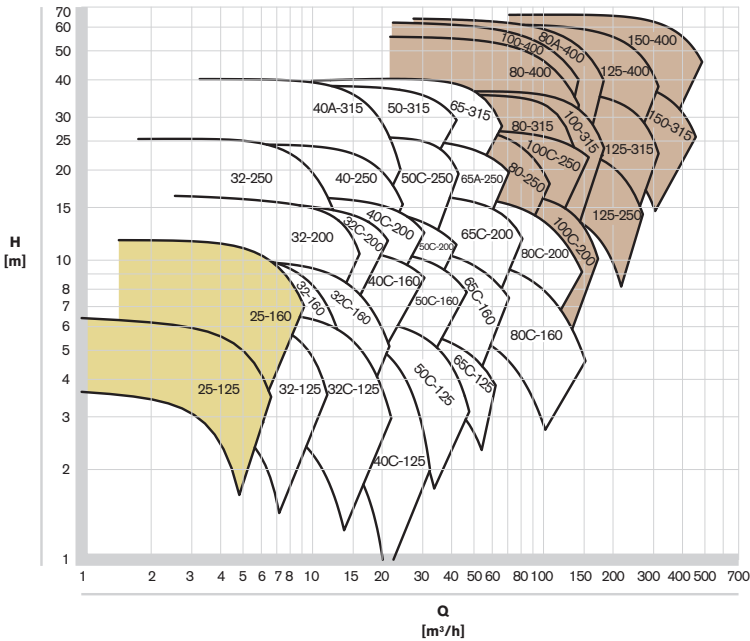

3000 rpm

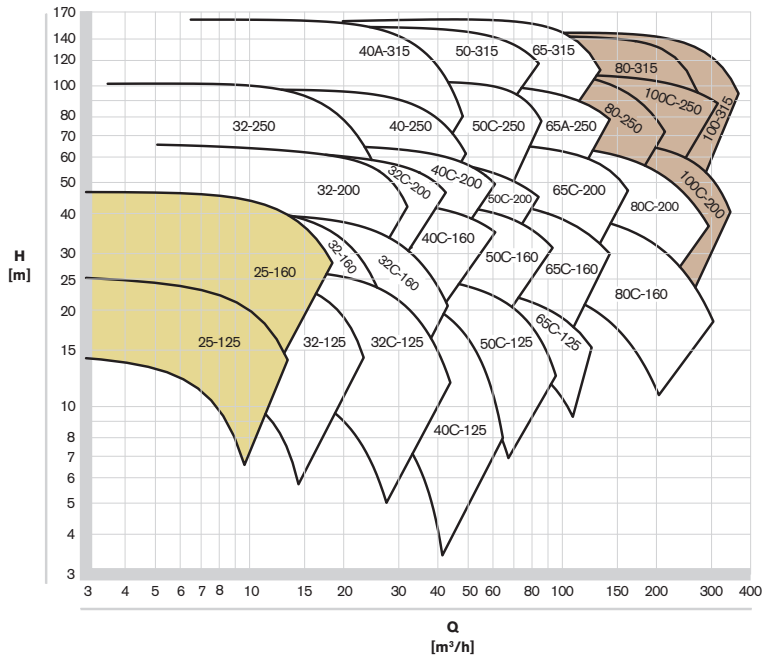

- only CMB types
- CM and CMB types
- only CM types

APPLICATIONS

- Solvents
- Acids
- Alkalis
- Volatile organic chemicals
- Hydrocarbons
- Hot process liquids
- Heat transfer oils
- Toxic liquids
- Corrosive liquids
- Heating water

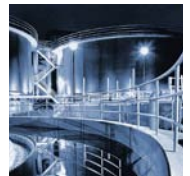
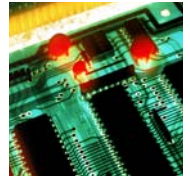

INDUSTRIAL SEGMENTS

- Chemical industry
- Pharmaceutical industry
- Petrochemical industry, refineries
- Water treatment
- Metal processing
- Recycling industry
- Refrigeration
- Heating
- Tank storage

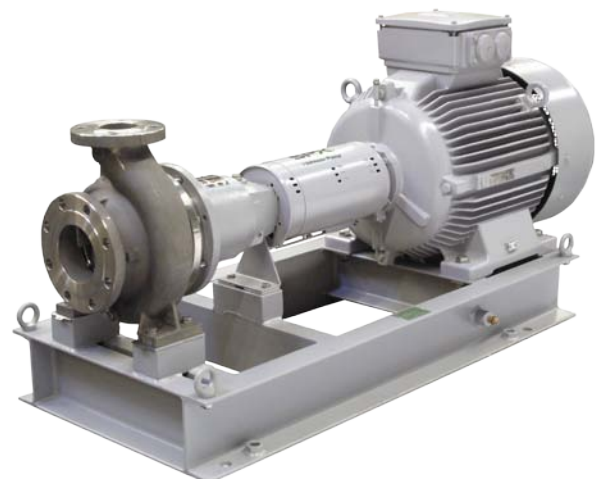

CombiMag / Bloc

SPXFLOW

Magnetic Drive Centrifugal Pumps

Your local contact:

<http://www.spxflow.com/en/johnson-pump/where-to-buy/>

SPX FLOW TECHNOLOGY ASSEN B.V.

Dr. A.F. Philipsweg 51, 9403 AD Assen

P.O. Box 9, 9400 AA Assen, THE NETHERLANDS

P: +31 (0)592 37 67 67

F: +31 (0)592 37 67 60

E: johnson-pump.nl.support@spxflow.com

SPX FLOW, Inc. reserves the right to incorporate our latest design and material changes without notice or obligation.

Design features, materials of construction and dimensional data, as described in this bulletin, are provided for your information only and should not be relied upon unless confirmed in writing. Please contact your local sales representative for product availability in your region. For more information visit www.spxflow.com and www.johnson-pump.com.

The green ">" is a trademark of SPX FLOW, Inc..

JP_441_GB Version: 03/2016 Issued: 03/2016

COPYRIGHT © 2016 SPX FLOW, Inc.